

Q7760A SLTA 10 Serial LonTalk[®] Adapter

INSTALLATION INSTRUCTIONS

BEFORE INSTALLATION

The SLTA-10 (Serial Interface or Serial LonTalk[®] Adapter) provides communication between the LONWORKS[®] Bus and either a PC serial port or approved modem using the SLTA-10 EIA-232 port. The SLTA-10 Q7760A2001 operates with the Light Commercial Building Solution and the Excel 10 series 2000 family of controllers. It interfaces with LONSPEC[™], LONSTATION[™], LONSTAT[™], and E-Vision software. The SLTA-10 Q7752A1011 operates with the Excel 10 VAV1 series 1000 controller and interfaces with LiveCare software.

There are two separate firmware images in the SLTA-10. The two separate images have different link layer protocols, network drivers, buffer capacity, and functionality. The two modes of operation are SLTA-10 NSI mode and SLTA-10 MIP mode. An externally accessible DIP switch at power-up controls the mode of operation.

In SLTA-10 MIP mode, the SLTA-10 is a replacement for the SLTA/2 Serial LonTalk[®] Adapter, with an improved form factor. The network connector on the SLTA-10 is the orange removable screw terminal instead of the RJ-45 used on the SLTA/2. The SLTA-10 input power options include 9 to 30 Vac or Vdc, or a 9 Vdc power supply. The SLTA-10 configuration DIP switches are accessible externally. The SLTA-10 enclosure has been improved to allow wall mounting without requiring a bracket.

CONFIGURING THE SLTA-10 HARDWARE

The SLTA-10 can be configured for direct communications with a PC serial port, or remote communications with a modem. Configure the SLTA-10 with its eight configuration switches on the adapters switch block (S1). The SLTA-10 firmware reads these switches to configure or enable features. Changes to the switch configurations do not occur until power is cycled on the SLTA-10. The switches are read immediately after a power reset. The configurations for Direct and Remote are different, see their separate sections.

Direct Connections LONSPEC[™] LONSTATION[™] LONSTAT[™] E-Vision and LiveCare

1. Set the switches for direct connection to an PC serial port as shown in Fig. 1.

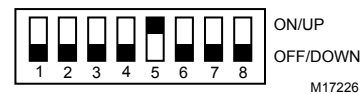

Fig. 1. Dip Switch Settings.

2. Cycle power to enable the new configuration on the SLTA-10.

Drivers

- NodeTalk: LONSPEC[™], LONSTATION[™], and LONSTAT[™] use the NodeTalk driver to manage SLTA-10 communications. The NodeTalk driver is built into the software.
- LDVSLTA.SYS: E-Vision and LiveCare use the LDVSLTA.SYS driver to manage SLTA-10 communication. This driver has not changed, and is included with both E-Vision and LiveCare. The Config.sys must be modified to call this driver. Add a line to Config.sys similar to Device=C:\E-Vision\ldvslta.sys /D1 /P1 /A.

NOTE: /Pn (n can be 1 or 2) determines the COM port.
/A means autobaud.

Remote Connections

Remote communication configurations vary greatly between the Light Commercial Building Solution and the Excel 10 controllers. Both systems require an approved modem connected to the EIA-232 port on the SLTA-10 with an SLTA modem cable (Honeywell part number 32002517-001; DB-9 male to DB-25 male non-standard). The PC must have the same modem. See Fig. 2.

NOTE: Do not select AutoBaud for remote connections.

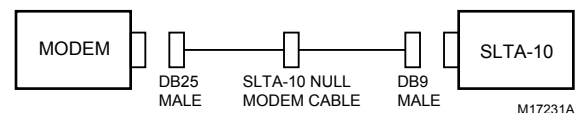

Fig. 2. Remote connection.



Approved Modem: US Robotics 56K external V.90.

Modem Dip Switch Setting:

3, 4, and 8 down. All other switches up.

LONSPEC™ and LONSTATION™

1. Configure the software tool for remote communication.
 - a. Open the project and the network.
 - b. Edit the network to include the phone number to dial.
 - c. Click the File pull-down menu.
 - d. Select Communication Settings.
 - e. Choose the port where the modem is connected (COM1 or COM2).
 - f. Choose the baud rate. Honeywell recommends 38400 bps.
 - g. Choose Modem connection type.
2. Configure the SLTA-10 for remote communications with switch 2 (Remote Host), 6 and 8 (38.4K bps) in the up position, as shown in Fig. 3.

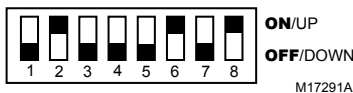

Fig. 3. Dip Switch Settings.

3. Enable new configuration by cycling power to SLTA-10.

NOTE: If problems are experienced due to a bad connection, set switch 8 down to return to 19.2K bps and repeat step 3.

E-Vision and LiveCare

Use SLTALink Manager software for remote communication with E-Vision or LiveCare. The SLTALink Manager is currently available free from the Echelon® web page.

DOWNLOADING SLTA-10 CONTROLLER SOFTWARE

1. Go to the site URL= <http://www.echelon.com>.
2. Click the self-extracting file SLTA.EXE on the Echelon web page.
3. Select the following options to get the SLTA.EXE zip file.
 - Services
 - Developers Toolbox
4. Enter Username and password.

NOTE: To obtain username and password select GET INSTANT ACCESS. There is no charge for a username and password.

- a. Select Drivers.
- b. Select the following information: LONWORKS® SLTA-10 NSI Mode Software and Microsoft® Windows™ 95 and NT Drivers, release 1.04, 765K zip file.
5. Download the LONWORKS® SLTA-10 Software for Windows NT and Windows 95.

INSTALLING THE SLTALINK MANAGER.

1. Click SLTA.EXE. LONWORKS® SLTA-10 installation starts automatically.
2. Follow instructions on the screen.
3. Select Yes to add DOS virtual device driver. The installation adds a device driver to the Config.sys file.

Example:

DEVICE=C:\LONWORKS\bin\LDVVDD.SYS /D1 /N"LonSLTA".

NOTE: To use the SLTALink Manager software the REM out the E-Vision driver in the Config.sys file.

Example:

REM DEVICE=C:\E-Vision\LDV\SLTA.SYS /D1 /P1 /A.

The user must REM out the driver not being used when switching between SLTALink Manager and SLTA-10 direct connect operation. After changing the Config.sys file, the computer must be rebooted for the new driver selection to be active.

NOTE: Do not use a /Pn switch when using the LDVVDD.SYS driver. The SLTALink Manager automatically handles the COM selection.

Setting Switches on SLTA-10:

1. On SLTA-10 set switch 2 (Remote Host), 4 (NSI) and 6, (19.2K bps) up. See Fig. 4.

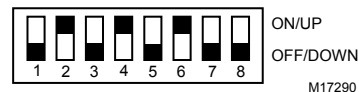

Fig. 4. Dip Switch Settings

NOTE: Honeywell recommends a baud rate of 19.2K bps.

2. Lower the baud rate if problems occur. Set the balance of switches down.
3. Connect LONWORKS® Bus to Network terminals.

CONNECTING THE MODEM

1. Connect the SLTA modem cable to approved modem and the EIA 232 port on SLTA-10.

NOTE: The SLTA modem cable is a unique cable with non-standard pin connections and grounding.

2. Connect the phone line.
3. Power up the modem.
4. Cycle power on SLTA-10 to send the configuration string to modem.

NOTE: The modem read and send LED flash when the configuration string is received from the SLTA-10. The SLTA-10 may need to be power cycled more than once for the string to be sent.

ESTABLISHING SLTALINK MANAGER CONNECTION TO REMOTE SITE.

1. Click SLTALink Manager.
2. From menu select Link then New.
3. Enter Name and select Remote for Link type. (See Fig. 5).
4. Select Next to go to the next screen.

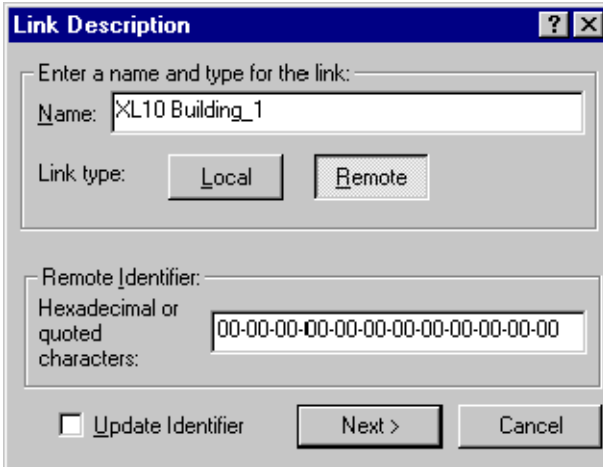

Fig. 5. Link Description Screen.

5. Enter phone number of remote site (see Fig. 6).
6. Select modem from Connect Using pull down menu.

NOTE: Modems listed in Connect Using were previously configured by Win 95 system.

7. Select Next to accept the information and continue.
8. No entry is required in the Link Properties screen. (See Fig. 7).
9. Select Finish to proceed.

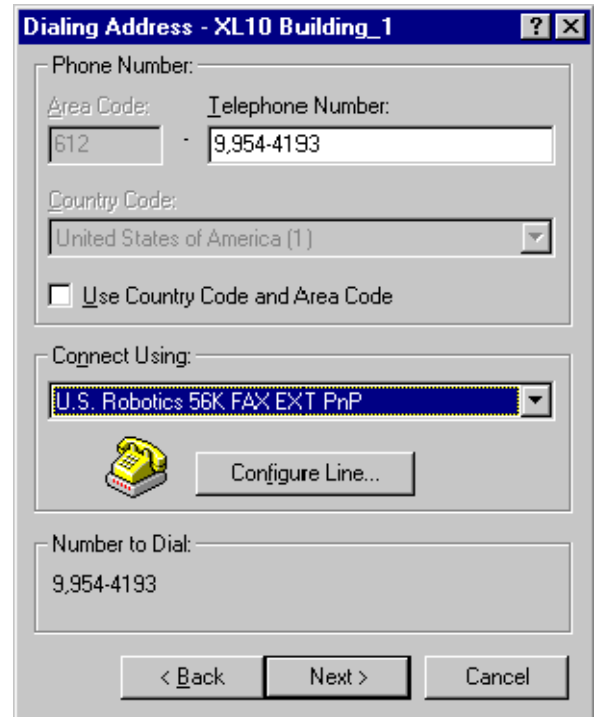

Fig. 6. Dialing Address Screen.

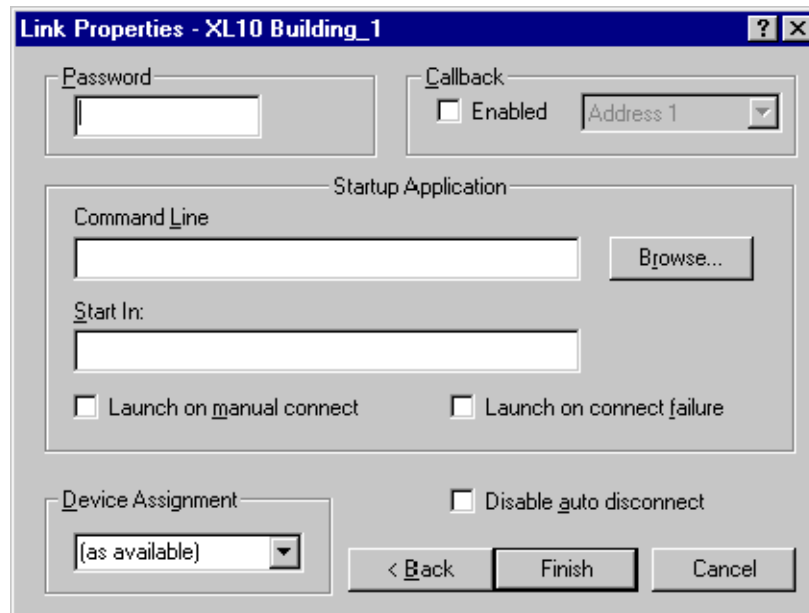

Fig. 7. Link Properties Screen.

10. Click Select/Action.
11. Select name of remote site.
12. Click Connect Now.

NOTE: The program dials out through the modem selected and connects to remote site. Upon a successful connection the status light in SLTALink Manager turns green.

13. Minimize SLTALink Manager.

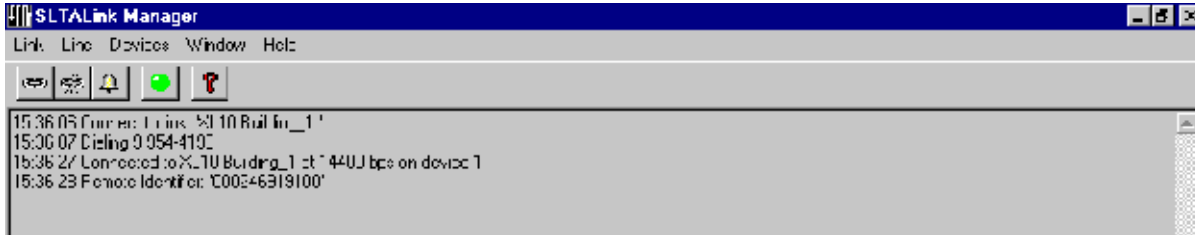

Fig. 8. SLTALink Manager Screen.

- 14. Start E-Vision.
- 15. Open Project.
- 16. Select View.
- 17. Click On-line.
You have remote communications.
See Fig. 9 for SLTA-10 dimensions, front and back views.

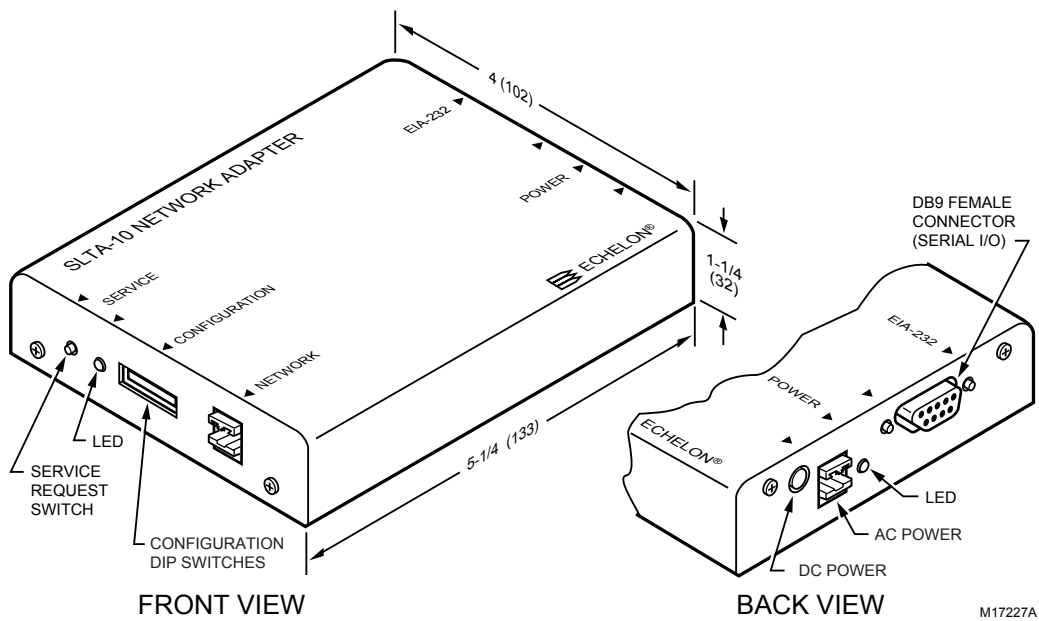

Fig. 9. SLTA-10 front and back.

See Fig. 10 for an internal view of the SLTA-10.

See Table 1 for SLTA-10 interface functions.

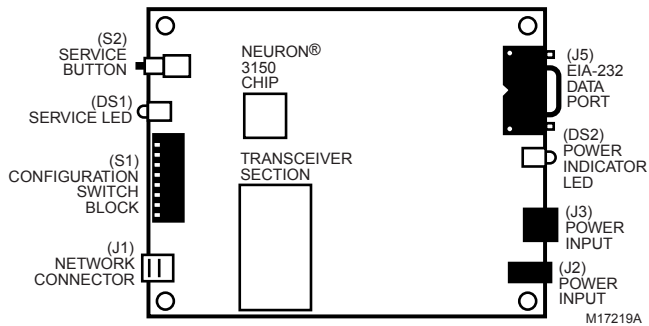

Fig. 10. Internal view of SLTA-10.

Table 1. SLTA-10 Interface.

Interface	Function
Service Button S2	Pressing this switch grounds the service request pin on the Neuron® Chip inside the SLTA-10. While this switch is pressed, the service LED should light to maximum intensity.
Service LED DS1	Yellow (LED) Indicates the Service Button is being pressed. If the Service button is not being pressed, there are three possibilities: ON: The SLTA-10 firmware has detected an unrecoverable error and/or the node has no application. Reboot the SLTA-10 from another network interface on the channel. Blinking: Node is configured. OFF: Node is configured or there is no power. Check LED.
EIA-232 Data Port J5	Connector for the EIA-232 serial I/O port. Standard DB9 female connection.
Network Connector 2 position J1	Orange connector for attachment to a twisted pair channel. The provided mating plug is Weidmüller PN135606 (obtain locally).
Unregulated AC/DC power input 2 position J3	Black connector for the power input. The provided mating plug is Weidmüller PN125911 (obtain locally).
Unregulated AC/DC power input barrel connector J2	Female 2.1 mm inside diameter and 5.5 mm outside diameter power input barrel connector.
Power indicator LED DS2	Green LED indicates presence of input power of the SLTA-10.

CABLING AND CONNECTIONS

EIA-232 devices are configured as either Data Circuit-terminating Equipment (DCE), or as Data Terminal Equipment (DTE). The SLTA-10 is a DCE device. A DCE device connects to a DTE device unless a null modem cable is used. Using a null modem cable, a DCE device connects to another DCE device, and a DTE device can connect to another DTE device.

The standard configuration for a PC port is a DTE device. A PC usually takes the terminal role in communications. Modems should always be DCE devices. To connect an SLTA-10 to a PC, connect one end of the serial cable to the SLTA-10, and the other end of the cable to the PC serial port. Connecting an SLTA-10 to a modem, requires a special null modem cable.

NOTE: A standard off-the-shelf null modem cable does not work with this configuration.

Honeywell offers the SLTA-10 Null Modem Cable (part number 32002517-001) that is a DB-9 male to DB-25 male null modem cable.

Attaching SLTA-10 to a Modem

IMPORTANT

You must use the specific null modem cable described in Table 2, to attach the SLTA-10 to a modem.

Table 2. DCE Modem To SLTA-10 Connection (DB-25 To DB-9).

Modem Signal Name	Cable DB-25 Male	Cable DB-9 Male	SLTA-10 (DCE) DB-9 Female
RXD—Pin 3	Pin 3	Pin 3	TXD—Pin 3
TXD—Pin 2	Pin 2	Pin 2	RXD—Pin 2
DCD—Pin 8	Pin 8	Pin 4	DTR—Pin 4
DTR—Pin 20 RTS—Pin 4	Pin 20 and Pin 4	Pin 6	DSR—Pin 6
GND—Pin 7	Pin 7	Pin 5	GND—Pin 5

See Fig. 11 to attach an SLTA-10 to a modem.

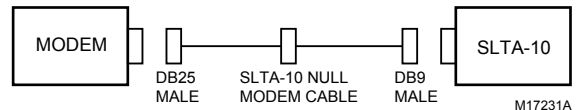

Fig. 11. Attach SLTA-10 to a modem.

! CAUTION

Equipment Damage Hazard.

This product contains components that are sensitive to static electricity. Before installing or removing the network or serial cables, touch earth ground with your hand to discharge any static electricity that may have accumulated.

Attach SLTA-10 to a PC with DB-9 Connectors (Direct Connection).

When connecting to a PC equipped with a DB-9 connector, use a straight-through cable with one end terminating in a DB-9 male connector and the other end terminating in a DB-9 female connector. See Table 3.

1. Plug the male end of the DB-9 connector into the SLTA-10.
2. Plug the female end of the DB-9 into the serial I/O port.

Table 3. PC DB-9 To SLTA-10 DB-9 Connection.

Signal Name	PC Connector DB-9 Male	Cable DB-9 Female	Cable DB-9 Male	SLTA (DCE) DB-9 Female
RXD	Pin 3	Pin 3	Pin 2	Pin-2
TXD	Pin 3	Pin 3	Pin 3	Pin 3
Signal Ground	Pin 5	Pin 5	Pin 5	Pin 5

Fig. 12 shows a DB-9 cable connecting a PC and an SLTA-10.

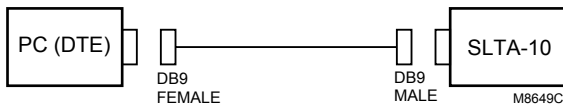

Fig. 12. DB-9 cable connection.

Attach SLTA-10 to a PC with DB-25 Connectors (Direct Connection).

Some PC serial I/O ports have a 25-pin male DB-25 connector.

When connecting to a PC equipped with a DB-25 connector, use a straight-through cable with one end terminating in a DB-9 male connector and the other end terminating in a DB-25 female connector. See Table 4.

1. Plug the male end of the DB-9 connector into the SLTA-10.
2. Plug the female end of the DB-25 into the serial I/O port.

Table 4. PC DB-25 To SLTA-10 DB-9 Connection.

Signal Name	PC Connector DB-25 Male	Cable DB-25 Female	Cable DB-9 Male	SLTA (DCE) DB-9 Female
RXD	Pin 3	Pin 3	Pin 2	Pin-2
TXD	Pin 2	Pin 2	Pin 3	Pin 3
Signal Ground	Pin 7	Pin 7	Pin 5	Pin 5

Fig. 13 shows a DB-25 to DB-9 cable connecting a PC and an SLTA-10.

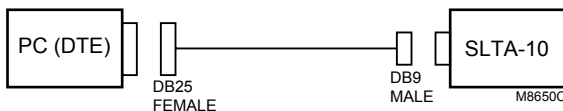

Fig. 13. DB-9 to DB-25 cable connection.

Attaching the SLTA-10 to a Network

The network connector for the SLTA-10 is an orange, two-conductor block type. Use the 2-pin conductor that comes with the SLTA-10 to connect to the twisted-pair network. See Fig. 14.

1. Connect the mini-phone plug end of the 32000180-009 SLTA Connector Cable to the LONWORKS® port on either a controller or a wall module.
2. Connect the wire end of the to the SLTA-10.

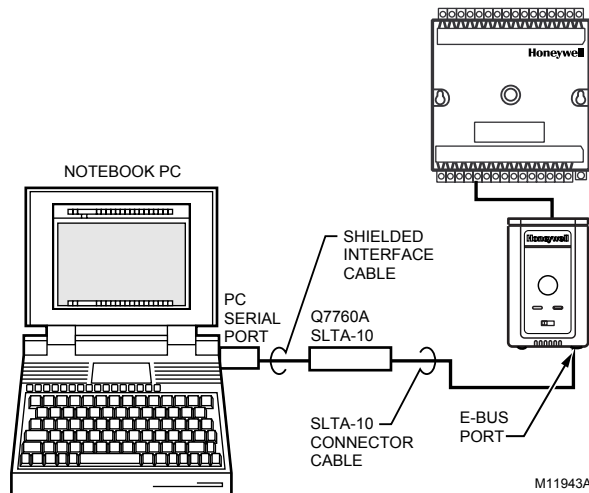

Fig. 14. Connecting the portable operator terminal to the LONWORKS® Bus.

Fig. 15 shows the SLTA-10 cable.

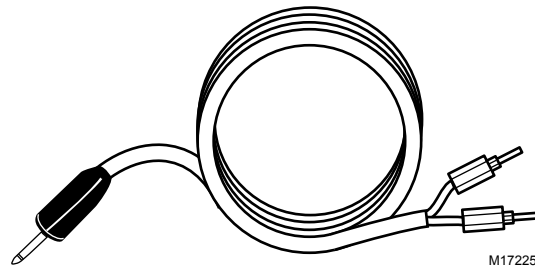

Fig. 15. SLTA-10 Connector Cable.

Supply power to the SLTA-10 after it is connected to the desired network. Table 5 has the specifications for power inputs to the SLTA-10. The barrel connector input, J2, is a standard female power plug with a 2.1 mm inside diameter and a 5.5 mm outside diameter (LZR Electronics part number HP114A, Radio Shack catalog number 274-1569, or equivalent, obtain locally). Echelon recommends a surge protector between the AC mains and the power supply.

Power supply jack J3 provides screw terminals with a provided Weidmüller input connector (PN 11261). This allows the SLTA-10 to connect to a 9 to 30 Vac/Vdc power supply.

Table 5. SLTA-10 Power Supply Requirements.

Power	Minimum	Nominal	Absolute Maximum
Unregulated DC	+9 Vdc	+12 Vdc	+30 Vdc
Unregulated AC	9 Vac	24 Vac	30 Vac

When power is connected, the yellow service LED flashes briefly and the green power indicator LED turns on. Once an SLTA-10 is powered and configured, the service LED remains off unless the service request switch is pressed.

IMPORTANT

Do not attempt to power an SLTA-10 from JP2 and JP3 simultaneously. Mechanical insertion of a connector into JP2 disables the input to JP3 (See Fig. 10).

ORDERING INFORMATION**Available Accessories:**

Part number 32000180-009 Portable Operations Kit (includes 9 Vdc power supply and SLTA-10 connector cable).

Part number 32002517-001 Modem Installation Cable (includes special null modem cable).

LONWORKS®, *LonTalk®*, *Neuron®* are registered trademarks of Echelon® Corporation.

LONSPEC™, *LONSTATION™*, *LONSTAT™* are trademarks of Echelon® Corporation.

Windows® is a registered trademark of Microsoft® Corporation.

Honeywell

Automation and Control Solutions

Honeywell International Inc. Honeywell Limited-Honeywell Limitée
1985 Douglas Drive North 35 Dynamic Drive
Golden Valley, MN 55422 Scarborough, Ontario
M1V 4Z9

ACS Control Products

Honeywell AG
Böblinger Straße 17
D-71101 Schönaich
Phone (49-7031) 637-01
Fax (49-7031) 637-493

